

Dental Equipment FOCUS

Issue 12
Summer 2012

ALL OFFERS VALID FROM 15/05/2012 TO 15/09/2012



CONTACT YOUR LOCAL
EQUIPMENT SPECIALIST

08700 10 20 41

EMAIL sales@henryschein.co.uk

ONLINE henryschein.co.uk

LIKE US ON [f](#) HenryScheinMinervaDental

FOLLOW US ON [t](#) @HenryScheinUK

HENRY SCHEIN®
MINERVA DENTAL

making life easier

Index

	Full Service Packages	3
	Full Surgery/Service Packages	4
	Treatment Centres	6
	Stools	14
	Intraoral X-ray Imaging	15
	Plant Room Equipment	16
	Cabinetry	18
	Decontamination	20
	Soft Tissue Laser	24
	CAD/CAM	24
	Education Courses	25
	Equipment Sell-off	26

Focus Issue 12

Welcome to your new Dental Equipment Focus Brochure.

We understand the challenges of running a successful practice and with the help of our local account managers, we can make your life easier with our:

- **Range** - the widest equipment range, servicing, digital imaging, software and financing
- **Value** - representing true value for money
- **Service focus** - personalised, local service at the highest level
- **Innovation** - the latest dental innovations and high tech equipment
- **Education** - a comprehensive selection of courses from Decontamination to Surgical
- **Expertise** - we can give you access to an additional range of experts on everything from equipment to decontamination to software

If you would like to receive essential product offers more regularly, then subscribe to our electronic updates by emailing me@henryschein.co.uk

LIKE US ON  HenryScheinMinervaDental FOLLOW US ON  @HenryScheinUK WATCH US ON  youtube.com/HenryScheinMinerva

Our Team

Our local equipment specialists can provide the advice and guidance you'll need to take advantage of technologies that will keep your business competitive and more productive. They will evaluate your requirements and help you choose the equipment that is best suited to your practice goals and budget.

EQUIPMENT SALES:

08700 10 20 41

EQUIPMENT SERVICE:

08700 10 20 49

sales@henryschein.co.uk

www.henryschein.co.uk

SPECIALIST ENQUIRIES:



ProRepair: **08700 10 20 48**

Financial Services: **01634 877450**

Software of Excellence: **0845 345 5767**

Quick Reference Guide...

To help you choose what equipment is right for your practice, we have established a simple guide which will allow you to compare products from the same category against each other based on features and value. Look out for the Platinum, Gold and Silver symbols as you look through this brochure.

-  Our Platinum Range benefits from high technology, ergonomic esthetics and the latest dental equipment innovations.
-  The Gold Range is ideal for practitioners that demand high performance, large choice of built-in options, sound ergonomics and a good return of investment.
-  The products in the Silver Range offer you excellent value for money, ease of use and contribute to a professional working environment.

Please note, sales calls may be recorded for training purposes. Offers valid from 15/05/2012 to 15/09/2012. E & OE. All prices exclude VAT and are subject to availability or while stocks last. Henry Schein Minerva reserve the right to correct clerical omissions and errors in this flyer. Please note all prices are subject to change. All pictures in this publication are for illustration purposes only. Henry Schein Minerva Terms and Conditions apply. * All finance options shown are subject to status, availability and full credit approval. Monthly payments are subject to VAT at current rate. An arrangement fee may be charged with the first monthly payment. Full details available upon request from Henry Schein Financial Services. Examples shown are not a formal offer of finance.

FACE THE CHALLENGE

Education to Equipment...

Henry Schein Minerva can deliver everything you need to run a highly successful dental practice in 2012.



Summer Specials

R7 Modular

SILVER RATING

Package includes:

- R7 Ambidextrous Treatment Centre
- Operating light with triple axis movement and removable handles
- Multimedia ready
- Endo Function ready
- Digital readout of functions and options
- Real speed and torque display on micromotor option
- Multifunction foot control allowing for hands-free chair and handpiece controls
- Clean water system
- Multiple user control function
- Double articulated headrest
- Rear mounted manifold with chair controls
- Compact space saving footprint



onthos

R7 Modular Package

FROM ONLY
£199
PER MONTH*

for 60 months

C4+ Package

FROM ONLY
£99
PER MONTH**

for the first 6 months



sirona
The Dental Company

C4+ Treatment Centre

PLATINUM RATING

Package includes:

- C4+ Treatment Centre with intraoral camera and screen
- Electric micromotor
- Fibre optic scaler
- Spittoon valve
- Operating light
- Integrated automatic disinfection system
- Multifunction foot control
- Interactive display
- Hands-free chair and handpiece operation

** After 6 monthly payments at £99, the finance plan will revert to standard 54 month plan. The 6 months at £99 plus VAT is available on all finance approved before 15/09/2012.

A3

SILVER RATING

All Inclusive Full Surgery Package

A3 Full Surgery Package Includes:

- **A3 Treatment Centre** with fibre optic tubing, scaler, spittoon valve and operating light
- **Premier Cabinet Set** with solid work surface, including sinks and taps and an integrated practical drop down corner desk
- **Progeny Preva Intraoral Wall Mounted X-ray**
- **Cattani Turbojet 1 Suction Pump** with amalgam separation
- **Surgery Drawings**
- **Pre-Installation Site Checks**
- **Installation by Henry Schein Engineers**



A3 All Inclusive Full Surgery Package

ALL THIS FOR ONLY

£17,995

PLUS ADD AN EXTRA FULL 3 YEAR
FULL INCLUSIVE WARRANTY FOR
AN ADDITIONAL £62 PER MONTH**

MODELS SHOWN HAVE SOME OPTIONAL EXTRAS AVAILABLE AT ADDITIONAL COST

HENRY SCHEIN®
MINERVA DENTAL

making life easier

Contact us today about Full Service Revolution...

08700 10 20 41

A3



Full Service Revolution

A3 Full Service Revolution Includes:

A3 Treatment Centre

3 years Call out charges

3 years Labour charges

3 years Parts

End of Year Full Service visits within contract period

Extendable to 5 years



A3 Full Service Package

FROM ONLY
£265
PER MONTH***

for 60 months

*** Full Service Contract. Terms and Conditions apply.
Image above shows some optional extras. Please contact us for details.

EMAIL sales@henryschein.co.uk

LIKE US ON HenryScheinMinervaDental

ONLINE henryschein.co.uk

FOLLOW US ON @HenryScheinUK

HENRY SCHEIN®
MINERVA DENTAL

making life easier



One of Europe's most sold Treatment Centre Brands

R7

GOLD RATING

The complete solution, whichever way you look at it

- Triple axis quality operating light
- Multi-function foot control for handpiece and chair functions
- Preconfigured for built-in Endo Function*
- Handpiece real speed and torque display with micromotor option
- 6 chair programs for multiple users
- Nurse controls
- Height adjustable, extendable and retractable nurses element
- Spittoon valve or amalgam separator option
- Removable swivel spittoon
- Easy ambidextrous function, allowing conversion to right or left
- Pre-configured for optional camera and screen
- LED operating light option
- Rear mounted nurses element option
- Multiple delivery system options
- Range of further options - please contact us

Ambidextrous

Mood



MODELS SHOWN HAVE SOME OPTIONAL EXTRAS AVAILABLE AT ADDITIONAL COST

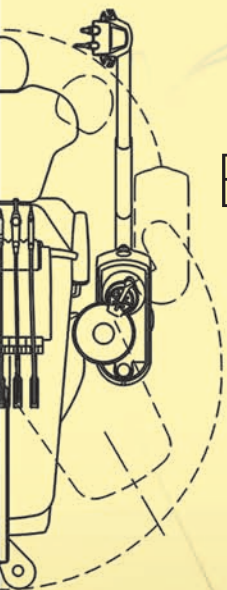
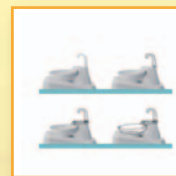

Bespoke

FROM ONLY
£255
 PER MONTH*
 for 60 months



Stools
 See page 14....



Full Service **Revolution**

ONE MONTHLY PAYMENT COVERS EVERYTHING**

Available Nationwide through your local Henry Schein Minerva Equipment Specialist

C8+ Treatment Centre

SILVER RATING

Sirona C8+ Full Service Package

FROM ONLY
£295
PER MONTH***
for 60 months

C8+ Full Service Revolution Includes:

C8+
Treatment Centre

3 years
Call out charges

3 years
Labour charges

3 years
Parts

Annual End of Year Full Service

With its compact footprint, the Sirona C8+ incorporates stunning design with flexibility to practices with modest space and tight monetary budgets.

*** Full Service Contract. Terms & Conditions apply.

The chair that has it all

THE STYLISH CENTRE POINT OF YOUR PRACTICE

The Sinus chair provides an exceptionally high level of comfort and practicality for both you and your patient. Chair movement is ergonomical and unbelievably smooth.

Sinus Treatment Centre

PLATINUM RATING

**CONTACT US
TO ARRANGE FOR
A SHOWROOM
DEMONSTRATION**



Cleaning and disinfection systems



Endo Function (optional)

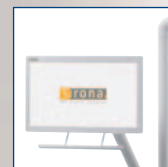

Digital and multimedia solutions



LED operating light



Headrest choice



Stunning design

MODELS SHOWN HAVE SOME OPTIONAL EXTRAS AVAILABLE AT ADDITIONAL COST

One brand, so many options...

Clesta II A/E

SILVER RATING

Flexible yet efficient in design

The Clesta II offers practicality, patient comfort and ergonomic over the patient delivery, either hanging tubing or continental style. It's design includes minimal visible tubing and integral umbilical hoses.



Optional 720S Operating Light

Features touchless sensor switch, patient mirror and composite curing safe mode

Features include:

- Optional fully integrated micromotor with digital display panel providing endo features
- 3 fibre optic outlets ("E" version)
- Rotating cuspidor with detachable bowl for improved hygiene and ease of cleaning
- Fully programmable chair

The **Clesta II Electric Version** is available as an over the patient, continental, cart or side arm delivery system.

CONTACT US FOR
**LATEST
PRICES**



Voyager

SILVER RATING

From right or left-handed in a few minutes

Base-mounted Swing-around Operator's Table

- 3 handpiece outlets with individual air and water control
- 3 way autoclavable syringe
- Clean water system
- Also available with cart and cabinet delivery options



Optional 720-VG Operating Light

Features toggle switches for ON/OFF control and light intensity settings

Chair Section

- Twin articulating removable headrest
- All handpiece and chair controls including preset positions, last position memory and auto return through the foot control
- Integrated floor box
- Swing out armrest



Cleo II A/E

GOLD RATING

Versatile knee break treatment centre

Advanced technology, improved ergonomics and the hygienic traits of the Cleo II ensure adaptability for patients and the Dental Team.

The flexibility of the Cleo II range ensures a large variety of bespoke configurations. The unique folding and extending chair provides unrivalled comfort and access for both operator and patient.



Other features of the Cleo II Chair...

- 2 preset positions
- Last-position memory (LP) and auto-return
- Air and water regulators
- MX fibre optic micromotor (on "E" version)
- Preset micromotor and torque control with auto-reverse and LED display (on "E" version)
- 2 x fibre optic outlets (on "E" version)

Automatic extendable legrest with manual override and auto safety stop. Folding and extending legrest safety feature ensures that the legrest retracts if contact is made with any object.



Optional 820S Operating Light
Features include touchless sensor switch, curing safe mode and triple axis head movement

Other features of the Nurse's Element...

- Assistant's three-way autoclavable syringe
- Easily detached HV and saliva ejector tubings
- Automatic bowl-flush and cup-filler
- Clean water system
- Assistant-side chair preset controls



Knee Break

MODELS SHOWN HAVE SOME OPTIONAL EXTRAS AVAILABLE AT ADDITIONAL COST

CONTACT US FOR
**LATEST
PRICES**

Choose from one of KaVo's qual
exceptional reliability, low mainte

Primus 1058S Compact

SILVER RATING



Estetica E50

GOLD RATING



The KaVo Knee Break Solution

- The workplace adapts to the patient and Dental Team
- Available as left or right handed version
- Use of proven KaVo technology
- Ease of operation
- Nurses height adjustable element with controls
- Ideal for treatment of children through height adjustable chair base
- Multimedia options
- Available as Continental, Hanging Tubing or Cart versions

The mid range chair which integrates with modern interfaces

- Integrated motor speed memorisation
- Direct selection key controls
- Configurable and expandable
- Soft upholstery and an ergonomically-shaped, fully-contoured seat recess with integrated lumbar support
- KL703 micromotor option and integrated torque control for endodontic work
- Flexible headrest options
- Optional integrated surgical module for over the patient version

MODELS SHOWN HAVE SOME OPTIONAL EXTRAS AVAILABLE AT ADDITIONAL COST

ity treatment centres with
nance and a long service life.



KaVo. Dental Excellence.

Primus 1058

SILVER RATING



Estetica E70

PLATINUM RATING



Proven, many times over

- Everything directly to hand: The workplace adapts to the dentist
- Available as left or right handed version
- Use of proven KaVo technology (Progress backrest, one-hand system, stability through floor mounting and many more)
- Ease of operation
- Nurses height adjustable element with controls
- Ideal for treatment of children through height adjustable chair base
- Multimedia options
- Good ergonomics

Suspended chair for optimum legroom

- Automated hygiene functions through integrated suction and turbine tubing disinfection devices
- Floating chair allows enhanced leg freedom for dentist and nurse
- Optional wireless multifunction foot control enhances the freedom of movement
- Modular, configurable and expandable making it ideally to customise to your needs
- The dentist element with built-in tray may be easily and precisely moved in every direction, allowing for optimum treatment workflow
- A wide selection of additional features which can be retrofitted at any time
- Interfaces for future specialisation and expansion

Stools

The dental stool is an integral part of the dental surgery, not only for the comfort of the dental team but for their health too.

Adopting the correct posture whilst seated can reduce the occurrence of work-related pain or injury both in the short term or later in life. A good stool can make a huge difference to your working well-being! Contact us, quoting the stool name, for more details or prices.

**QUALITY
NURSES
STOOLS**
PRICES FROM
AS LITTLE AS
£269



Universal DSSA



Anthos S7
Doctor's Stool



Anthos S8
Nurse's Stool



Anthos S9
Ergonomic Stool



Universal MDPN



Universal 305 MDP2



Universal DS



Universal DS4S



Universal 306 DS4N



Murray Advance
SADV/GT Dentist's Stool



Murray Advance
HADV/GN Assistant's Stool



Murray Gemini
HGEM-SAB



Universal DSWN



Universal DSWS



Sirona Carl Manual



Sirona Hugo



Belmont IC-TILT



Belmont IC-DTS



Bambach Saddle Seat

Nomad Pro Handheld X-ray System



PLATINUM RATING

The Nomad® Pro is truly portable

Key Benefits Include:

- Only one unit per 2 or 3 surgeries
- No more bulky arms to attach to the wall
- Patient confidence through presence of Dental Team
- Safe - multiple third party studies have proven that Nomad HAS A SAFETY RECORD
- Class leading 0.4mm focal spot insures razor sharp images
- DC: Ideal for Digital Imaging
- Logical: No reason not to consider this portable X-ray



Progeny Preva

PLATINUM RATING

Sharp images through one of the smallest focal points

- Very Sharp Images
- Ease of use
- Large display, easy to understand icons
- Unsurpassed arm stability
- Adjustable kV, mA and time
- 0.4mm focal spot
- Exceptional imaging quality
- Easy to programme additional settings



CONTACT US FOR
**LATEST
PRICES**

Also available, Intraoral X-ray units by...



EMAIL sales@henryschein.co.uk
ONLINE henryschein.co.uk

LIKE US ON HenryScheinMinervaDental
FOLLOW US ON @HenryScheinUK

HENRY SCHEIN®
MINERVA DENTAL
making life easier

Plant Room / Suction Units

(H) 2050mm
(W) 640mm
(D) 610mm



Dürr Power Tower PTS 200

- Complete plant room solution within a compact installation surface of only 0.4m²
- For one or multiple surgeries
- **Ideal where space is limited**
- Noise level of only 54dB(A)

(H) 920mm
(W) 560mm
(D) 520mm

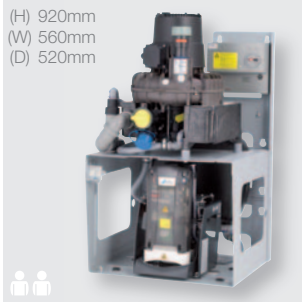

Dürr VSA 600 S semi wet Suction System Assembly

- Integrated amalgam separator
- The floor stand and expansion tank assembly can also be wall mounted

(H) 470mm
(W) 310mm
(D) 310mm

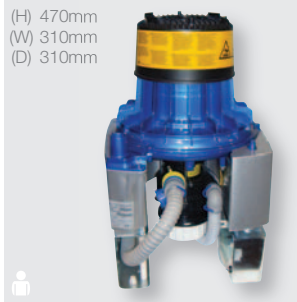

Dürr VSA 300 S semi wet

- A compact and powerful integrated amalgam separator
- Over 97% amalgam separation rate
- Noise level: approx 63 dB(A)

(H) 950mm
(W) 500mm
(D) 500mm

NEW



Medentex Amalmed Max semi wet centralised suction pump

- Central suction system, ideal for multi-surgery installations
- Easy amalgam waste recuperation
- Bespoke solutions

(H) 650mm
(W) 400mm
(D) 335mm



Cattani TurboSmart A semi wet

- Variable motor speed adjusts the airflow accordingly
- Can easily be converted from a 2-surgery to 4-surgery unit via a software upgrade

(H) 360mm
(W) 560mm
(D) 230mm

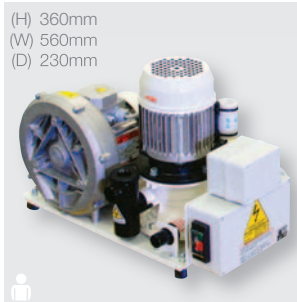

Cattani Turbo Jet 1 semi wet

- Integrated amalgam separation
- Motor protected by a thermal device
- Sound pressure level with canalised air 61 dB(A)

CONTACT US FOR
LATEST PRICES

Plant Room / Compressors

(H) 660mm
(W) 480mm
(D) 370mm



Dürr Tornado 1 without Dryer

- Anti-bacterial tank coating
- 67 l/min at 5 bar
- Tank: 20 litres
- Noise: 64 dB(A)
- Weight: 32kg

(H) 660mm
(W) 490mm
(D) 430mm



Dürr Tornado 2 without Dryer

- Anti-bacterial tank coating
- 125 l/min at 5 bar
- Tank: 20 litres
- Noise: 68 dB(A)
- Weight: 38kg

(H) 861mm
(W) 638mm
(D) 665mm



Jun-Air 2xOF302-40MD2

- Oil-free, 2/3 user dental, compressor with dryer, mounted in cabinet
- Tank: 40 litres (10.6 Gallons)
- Noise: 50 dB(A)
- Weight: 112kg

(H) 678mm
(W) 581mm
(D) 556mm

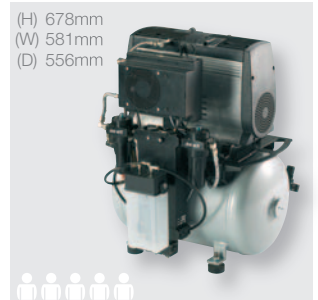

Jun-Air OF1202-40BD3

- Oil-free, 5 surgery compressor
- Tank: 40 litres (10.6 Gallons)
- Noise: 76 dB(A)
- Weight: 70kg (154 lbs)

Special Trade-in Offer

WIN YOUR COMPRESSOR



Trade-in your old compressor
and we will give you £1,000
towards a new Dürr Tornado 2.*

The customer with the oldest
dental compressor traded-in will
receive their Dürr Tornado 2
absolutely Free of Charge!!!

Terms & Conditions

*Trade-in is based on the Tornado 2 with Dryer. R.R.P. of £2,913. Only one entry per account. Promotion valid on compressors purchased between 15/05/12 and 15/09/12. The winner will be notified within 30 days. No cash alternative is available. Compressor will be charged on sale and a credit established if purchaser is the winner of this competition. E&OE.



EMAIL sales@henryschein.co.uk

LIKE US ON  [HenryScheinMinervaDental](https://www.facebook.com/HenryScheinMinervaDental)

ONLINE henryschein.co.uk

FOLLOW US ON  [@HenryScheinUK](https://twitter.com/HenryScheinUK)

 **HENRY SCHEIN®**
MINERVA DENTAL

making life easier

Premier Cabinetry

Over 100 years of unparalleled high quality craftsmanship

Choose an innovative and flexible bespoke layout designed by our experts. Select front panel materials, designs and colours from an extensive range. Customise sinks, taps, handles and other accessories to meet your budget.



Sensor operated tap options

Drawers manufactured to highest quality, with a focus on attention to detail

Corian®, alternative solid surface or laminate worktops available to suit every taste and budget

Hands-free (concealed) bin operation

Self soft closing drawers and doors

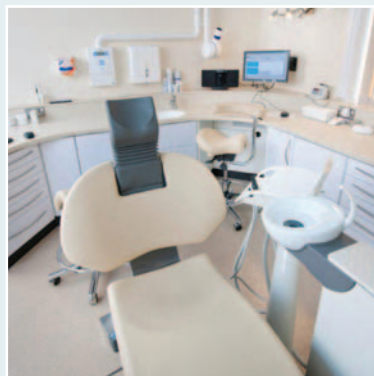
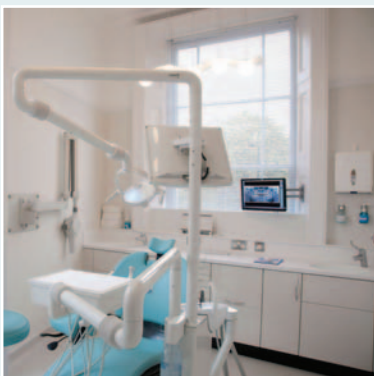

Steriwall by Richard Mitzman

The outstanding alternative to traditional L-Shape cabinetry



The Concept

The 'Steriwalls' concept created by Dr Richard Mitzman features a 'wall' of cabinets that divides the surgery from the sterilisation area which can be accessed from both sides.

Alternatively the 'wall' can be the single sided Steriwall Concept, creating a smart, space saving cabinet feature in your practice.

Advantages for the Practice

- High visual impact
- Allows the maximization of available space, so ideal for small or narrow surgeries
- Efficient and productive
- Very efficient use of available space
- Keeps defined areas clean and tidy
- Eye catching, glass work surface alternatives
- Modern look
- Single surgery option
- Mobile carts included
- Ideal when working with a centralised LDU

[View these alternative concepts in your local Henry Schein Minerva Centre of Excellence Showrooms](#)

Steriwall

FROM ONLY **£165** + installation

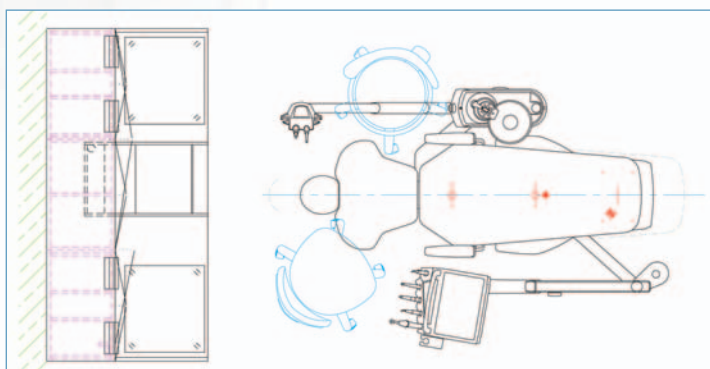



Local Decontamination Equipment

MELAG MELAtherm Revolutionary

MELAtherm

£299.95 PER MONTH* for 36 months

Price incl. VAT, Basis Basket 00188, Washing Basket G, Small Parts Container 00133, Insert Rack 00180, Instrument Basket 00184, MELAflash CF-Card, 3 Years Full Service and Validation Contract

What's included...

- Active drying
- HEPA Air filter
- Built in water softener
- Integrated data logger
- Integrated process agents storage and dosing unit
- Integrated process monitoring of spray arm rotation and spray pressure
- RO water connection

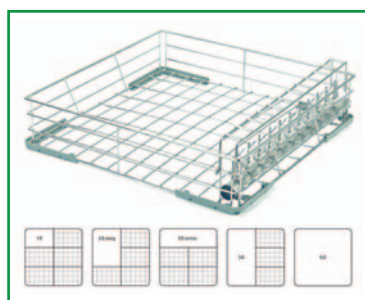

Basis baskets are available with or without an injector rail depending on the purpose of use. There are six useable tray segments for optimal utilisation

Other features...

- 15 Amp or 3 Phase power supply
- Handpiece adaptors for up to 11 handpieces available
- 5 programs



Thermodent Neutraliser 5 litres

1048801 

Thermodent Rinse 1 litre

1048803 

Thermodent Liquid 5 litres

1110591 



Optimised in practice - the washing chamber provides sufficient space for your instruments



Metering and monitoring of the process agents



Documentation via CF card or network



Active drying

The New Standard in Washer Disinfectors

Underbench Washer Disinfecter

Fits under Standard
600mm deep worktop!

Frees up critical work surface area and there
is no need for a separate dosing cabinet



Options / Baskets & Accessories

CONTACT US FOR
ALL MELATHERM
ACCESSORIES



Basis basket
with injector rail
00197 Code: 1120467

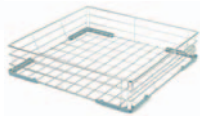

Basis basket
without injector rail
00188 Code: 1120468



Small parts container
00133 Code: 1120470



Instrument basket compact
00195 Code: 1121676



Instrument basket for
standing instruments
00184 Code: 1120469



Perforated cartridges with lid
00185 Code: 1120510



Dividing inserts for
perforated cartridges
00191 Code: 1120471



Insert rack for scissors
or clamps, Flex system
80120 Code: 1120889

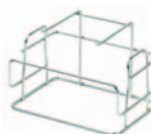

Insert rack for impression
trays, Flex system
80110 Code: 1120888



Insert rack for 3 perforated
cartridges/wash trays
00180 Code: 1120511



Washing basket G
00131 Code: 1121677



Flex basket 1
80010 Code: 1120885



Insert rack for 4 perforated
cartridges/wash trays
80040 Code: 1121675



Distance collar
55120 Code: 1121673



Three-way distributor
73903 Code: 1120897



Flex basket 2
80020 Code: 1120886



Locking screw
for injector rail
00198 Code: 1121669



Adapter for handpieces,
Ø 16mm
73900 Code: 1120507



Filter disc for adapter
for handpieces
64375 Code: 1121672



Adapter for handpieces,
Ø 22mm
73902 Code: 1120509



Local Decontamination Equipment

Rapid Sterilisation

It now only takes 12 minutes!

DAC Universal for

- All in one sterilisation - disinfection - lubrication device for handpieces
- Automated procedure: 6 handpieces or turbines in 12 minutes
- Very minimal manual handpiece handling
- Reduced oil consumption



DAC Universal for B.A.

£229.95 PER MONTH* for 36 months

Price incl. VAT, Datalogger, 3 Years Full Service & Autoclave Validation Contract

Melag **MELAquick 12+**

- Save time and money by sterilising instruments in only around 7 minutes
- Drying through connection to compressed air supply
- Three Class S programs: all programs comply to EN 13060 European Standard
- Integrated water quality measurement
- Class "S" rapid autoclave
- Compact size

Specifications:

Dimensions: (H) 460mm x (W) 250mm x (D) 450mm
 Chamber: (Ø) 90mm x (D) 200mm, volume 1.35 litres
 Power Supply: 220-240 volt / 50/60Hz / 2050 Watt



MELAquick 12+

£184.95 PER MONTH* for 36 months

Price incl. VAT, Datalogger, 3 Years Full Service and Validation Contract

Melag **MELAdem 47**

- Protect your instruments and your autoclave
- Quality water on tap for your autoclave needs
- Triple water filtering system

Specifications:

Module: (H) 470mm x (W) 390mm x (D) 150mm



LDU Package Offer

Local Decontamination Units including solid surface tops, stainless undermounted sinks, tap and vinyl front panels...

£2,849.95#

Price excludes MELAtherm Washer Disinfector and installation



The New Standard in Autoclaves

MELAG

A Trusted World Leading Brand



MELAG are committed to supplying suitable devices and methods that ensure that your decontamination requirements are always met. Quality consciousness, reliability, and innovative eagerness, plus the highest in safety standards, have made the family-run enterprise MELAG one of the world's leading producers of sterilisation equipment. Verification of its success has been the supply of more than 400,000 units worldwide to date since 1951.

MELAG **Vacuklav 31 B+**

PLATINUM RATING

- Vacuum autoclave
- Easy refill
- Large choice of available cycles
- Quick release connector or direct waste plumbing
- Class B and Class S cycles
- Optimum usage of sterilisation chamber (up to 5 trays)
- Noise suppression feature included
- Large range of printer options to suit your individual practice

Vacuklav 31 B+

£219.95 PER MONTH* for 36 months
Price incl. VAT, Datalogger, 3 Years Full Service and Validation Contract

Specifications:

Dimensions: (H) 485mm
x (W) 425mm x (D) 570mm
Chamber: 250mm x
350mm, volume 18 litres
Power supply: 230 Volt /
50 Hz / 2,100 Watt



MELAG **Euroklav 29 VS+**

GOLD RATING

- Fast, compact and Class S autoclave
- Powerful, efficient and simple pre-sterilisation vacuum pump
- Large chamber but compact in size
- Integrated clean and waste water tanks
- 20 minutes Quick Program for unwrapped instruments

Euroklav 29 VS+

£184.95 PER MONTH* for 36 months
Price incl. VAT, Datalogger, 3 Years Full Service and Validation Contract

Specifications:

Dimensions: (H) 485mm
x (W) 425mm x (D) 570mm
Chamber: (Ø) 250mm x
350mm, volume 17 litres
Power supply: 230 Volt /
50 Hz / 2,100 Watt



MELAG **MELAtronic 23 EN**

SILVER RATING

The MELAtronic 23EN works according to the fractionated gravity system and provides "Class N" and "Class S" sterilisation programs. It satisfies the strict requirements of the European standard EN 13060.

- Network capable through MelaNet and MelaView
- Electronic data logger available

MELAtronic 23 EN

£149.95 PER MONTH* for 36 months
Price incl. VAT, Waste Water Bottle, 3 Years Full Service and Validation Contract

Specifications:

Dimensions: (H) 380mm
x (W) 520mm x (D) 590mm
Chamber: (Ø) 230mm x 450mm, volume 19 litres
Power supply: 230 Volt / 50 Hz / 1,600 Watt



BIOLASE *iLase*TM

Soft Tissue Laser

FROM ONLY
£2,995

- The ideal everyday tool
- Contouring and crown lengthening
- No foot pedal or power cord
- Truly portable
- 5W peak power in Comfort Pulse
- 10 presets and 2 custom programs
- Ideal 940nm wavelength - no heat and no tissue shrinkage
- Webinars and training sessions in Glasgow, Leeds, Cardiff and London available
- Good selection of easy to use, hygienically disposable tips



that's more like it...

Instant in-house restorations

CEREC[®]

It's now even easier to create restorations with digital technology...

- Work on multiple restorations simultaneously
- New simplified user interface
- Intuitive workflow
- New design tools
- Photorealistic graphics

CONTACT US FOR
AN IN-SURGERY
SOFTWARE
DEMONSTRATION



Bluecam - capture images automatically and quickly



MCXL - in-surgery milling unit allows true one session restorations



Ceramic blocs from leading suppliers; 3M, Ivoclar, Vita and Sirona

Education



Laser Education Programme for Dental Practitioners 2012

Diode in Laser Dentistry Foundation Course

7 hours verifiable CPD

Key Learning Objectives:

- Core knowledge on the safe application of dental lasers
- Update your knowledge on the latest research in laser dentistry
- Study the latest techniques of the use of the diode laser in clinical dentistry
- Gain hands-on tutored experience

CARDIFF

FRIDAY 20TH JULY 2012

Cost: £210^{+VAT}

Periodontal Laser Surgery Course

7.5 hours verifiable CPD

Maximum number of participants: 12

Key Learning Objectives:

- Learn how to integrate laser periodontal therapy into your clinical practice
- Hands-on tutored experience of advanced laser periodontal surgery
- Latest research in laser periodontology
- Raise your treatment skills to a new level and optimise your investment in laser dentistry

CARDIFF

FRIDAY 1ST JUNE 2012

LONDON

FRIDAY 7TH SEPTEMBER 2012

Cost: £210^{+VAT}

A Practical Introduction to Laser in Dentistry: Two Day Intensive Course

14 hours verifiable CPD

Maximum number of participants: 6

Key Learning Objectives:

- Core knowledge on the safe clinical application of dental lasers
- Update your clinical knowledge on the latest research in laser dentistry
- Study the latest techniques and methods of implementing different types of lasers in dentistry
- Gain hands-on tutored experience of both soft and hard tissue laser

LONDON

FRIDAY 13TH - SATURDAY 14TH JULY 2012

Cost: £900^{+VAT}

CEREC® Education Programme 2012

FREE CEREC® Webinars

1 hour verifiable CPD

Explore the benefits of CEREC® Technology!

- Introduction to CEREC® Dentistry is the ideal course for those who have just purchased a CEREC®, joined a CEREC® practice or simply interested in finding more out about CEREC® technology. We've compiled exclusive tips and expert advice on the new CEREC® Software 4.0. Watch and learn from our expert Dr John Moore as he takes you through the amazing new features of the most powerful and dynamic CEREC® software to date.

EVENING WEBINAR

TUESDAY 19TH JUNE 2012

LUNCH & LEARN WEBINAR

THURSDAY 27TH SEPTEMBER 2012

FREE

CEREC® Test Drive & Tuition

2.5 hours verifiable CPD

Test Drive the new AC Bluecam!

CARDIFF

WEDNESDAY 27TH JUNE 2012

ALDERLEY EDGE

WEDNESDAY 4TH JULY 2012

LONDON

TUESDAY 10TH JULY 2012

AYLESBURY

FRIDAY 7TH SEPTEMBER 2012

MANCHESTER

WEDNESDAY 12TH SEPTEMBER 2012

GLASGOW

WEDNESDAY 19TH SEPTEMBER 2012

Cost: £45^{+VAT}

Developing Your Practice The Digital Way

2.5 hours verifiable CPD

Key Learning Objectives:

- New CEREC® 4.0 Software
- CEREC® Staining and Glazing Techniques - guide to characterising and finishing CAD/CAM ceramic restorations
- CEREC® Meets Implantology - combine 3D imaging with CEREC® for your implant planning
- Sirona Connect internet portal

CARDIFF

WEDNESDAY 18TH JULY 2012

LONDON

WEDNESDAY 24TH OCTOBER 2012

LEEDS

WEDNESDAY 14TH NOVEMBER 2012

Cost: £20^{+VAT}

MORE INFORMATION/BOOKINGS: **029 2044 2818**

VIEW ALL OUR AVAILABLE COURSES:

www.henryschein.co.uk/education

HENRY SCHEIN®
MINERVA DENTAL

EDUCATION & DEVELOPMENT

EMAIL sales@henryschein.co.uk

LIKE US ON HenryScheinMinervaDental

ONLINE henryschein.co.uk

FOLLOW US ON @HenryScheinUK

HENRY SCHEIN®
MINERVA DENTAL

making life easier

Summer Ex-Showroom & Sell Off

Sale

ONLY AVAILABLE AS LONG AS STOCKS LAST

SAVE £1000'S OFF R.R.P.



Cattani Suction Units

- Pal 22 suction motor • Turbojet 1 with quiet hood
- Turbojet 2 with soundproof • Turbo Compact + suction unit

Prices from
£990
each

Sirona Intraoral X-ray

- Heliodent Vario with XL long arm (length 200cm)

£1,395

Cattani Compressor

- 2 surgery, oil-free, with dryer

£990

Kodak Intraoral X-ray

- Kodak 2200 Irix mounted (arm 188cm). Long/extra long arm lengths available. Fits on Trophy wall plate.

£1,595

Jun-Air Compressor

- OF1201-HD2 single surgery compressor with dryer

£995

Belmont Intraoral X-ray

- Belray 096RK free standing unit

£1,395

Jun-Air Compressor

- OF1201-MD2 single surgery compressor with dryer and cabinet

£1,450

Belmont Intraoral X-ray

- 096C ceiling mounted

£1,690

Bambi Compressor

- DT23QD oil-free compressor

£995

Dürr X-ray Developer

- XR25 developer

£1,295

Sirona Lighting

- C8+ Fantastic ceiling mounted operating light

£2,190

Baisch Cabinet Sets

- Straight run of 5 metal cabinets with 1 sink in various colours

£2,990

B2M Bucco Lighting

- 6 tube lighting panel

£490

Belmont SP Cleo

- Colour: Regimental Blue, 3 x tubings, ultrasonic scaler, clean water system, spittoon valve, NDL-SP operating light

£13,950

All images are for illustration purposes only.
Call us for exact specification

Highlights

Belmont SP Cleo

- Colour: Light Grey
- 4 x Midwest tubing
- Autoclavable 3/1 syringe
- Clean water system
- Dürrr spittoon valve
- NDL-SP operating light



£12,950

Sirona C8+

- Colour: Pacific
- Operating light
- Spittoon valve
- Scaler
- Electric micromotor
- Monitor and camera on monitor
- Multifunction foot control



£14,990

Sirona C8+

- Colour: Aubergine or Planet Blue
- Flat headrest
- Narrow backrest
- 2 x F/O tubings
- Clean water system
- Spittoon valve
- Operating light



£9,990

Pelton & Crane 3004 Chair

- Colour: Mulberry
- Ambidextrous
- KaVo TLC electric micromotor
- Satelec ultrasonic scaler
- 2 x F/O tubings
- 3/1 syringe
- Triple Axis operating light
- Doctor and dentist stools



£6,490

Ex-Showroom KaVo E50T

- Chrome Edition
- Colour: Chocolate
- Hanging tubing system
- KL702 micromotor
- Piezo LED scaler
- 2 x F/O tubings
- Wireless foot control
- USB Port
- Spittoon valve
- 2 stools
- Operating light



£13,950

Sirona Teneo

- Therapie Package
- Wireless foot control
- Motor driven headrest
- Active lumbar support
- Message function
- BL ISO micromotor
- Sirosonic TL ultrasonic scaler
- Amalgam separation
- LED view ceiling mounted operating light 2.5 - 3.4m



£25,990

Equipment Service

WHY WAIT FOR THAT COSTLY BREAKDOWN?

With our current range of fixed price servicing[∞], there has never been a better time to book your service.

[∞] Contact us for a list of equipment serviced

Contact your Equipment Servicing Specialist
08700 10 20 49



- Full care and maintenance programmes available on Equipment, Digital Imaging, Laser and CEREC CAD/CAM products
- Nationwide local support
- Manufacturer-approved service and repairs
- New equipment installation and training
- Manufacturer-trained technicians
- CEREC annual servicing
- Emergency telephone support from technical experts

 **HENRY SCHEIN[®]**
EQUIPMENT SERVICE

Invest & Benefit Now - Pay Later Financial Services

Contact Henry Schein Financial Services about our latest tax efficient Finance Schemes:

- Hire Purchase
- Finance Lease
- Contract Hire
- Full Service Packages
- Low Start Payment Plans
- Deferred Payment Schemes

*Finance offered is subject to status and credit approval.

Contact your Financial Services Specialist
01634 87 74 50

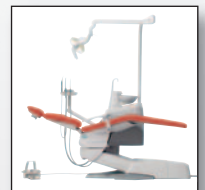

- Low rates
- Pre-approval up to £75,000 with no financials*
- Tailored schemes
- Terms from 1-7 years
- Free up existing credit lines and working capital
- Fast pre-approval
- 98% approval rate

 **HENRY SCHEIN[®]**
FINANCIAL SERVICES

Visit your Local Showroom...



**London
Marble Arch
Centre of
Excellence**
18 Stanhope Place,
London W2 2HH
Tel: 0207 298 1980

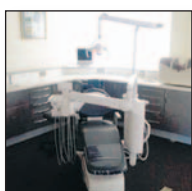

**Scotland
Showroom
Glasgow**
Unit 4, Clydebank
Business Park,
South Avenue,
Clydebank,
Glasgow G81 2LG



**South West
Showroom
Cardiff**
Courtney House,
Pacific Business Park,
Pacific Road,
Cardiff CF24 5HU



**Leeds
Centre of
Excellence**
Unit 4, Centre 27,
Bankwood Way,
Birstall,
West Yorkshire
WF17 9TB